



# Conceitos Básicos de Modelagem Hidrológica



Camilo Daleles Rennó  
I Escola de Primavera  
Santa Maria, setembro 2008

# Modelos

## O que é um modelo?

- » Modelo é a representação conceitual de um fenômeno
- » Tipicamente o modelo se referirá a apenas alguns aspectos do fenômeno em questão

## Dois modelos de um mesmo fenômeno deveriam ser iguais?

- » Não necessariamente
- » Cada modelo pode ter um objetivo diferente ou ainda ter diferenças conceituais ou de implementação decorrentes de decisões tomadas durante o desenvolvimento do modelo

# Modelos

## Quais as etapas da modelagem?

- » Essencialmente deve-se
  - » caracterizar o sistema na qual o fenômeno se insere
  - » fazer algumas suposições sobre como os vários componentes trabalham e se interagem
  - » traduzir tudo em equações/procedimentos e um programa de simulação
  - » fazer a validação
- » É muito importante compreender o papel das suposições feitas durante o desenvolvimento do modelo

## O modelo é bom?

- » Explica observações passadas?
- » Prediz observações futuras?
- » É generalizável?
- » É fácil de usar?
- » Consegue estimar o grau de confiança dos resultados?
- » É simples?

# Modelos

## E para que modelar?

- » Explicitar hipóteses
- » Avaliar diferentes combinações de eventos
- » Simular condições inexistentes ou muito raras

## Há limites para se modelar um fenômeno?



fonte: John Barrow

# Modelagem Ambiental

processos ambientais

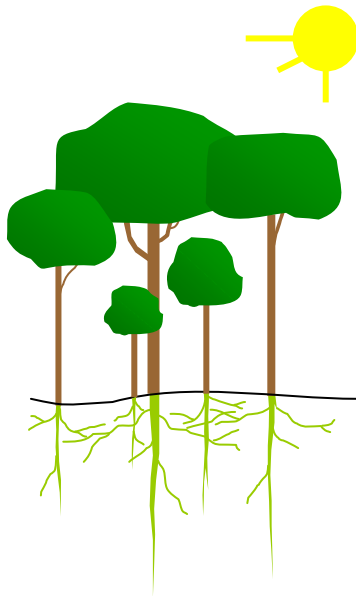

- \* tridimensionais
- \* dinâmicos
- \* comportamentos não lineares
- \* componentes estocásticos
- \* múltiplas escalas de tempo e espaço

# Modelagem Ambiental

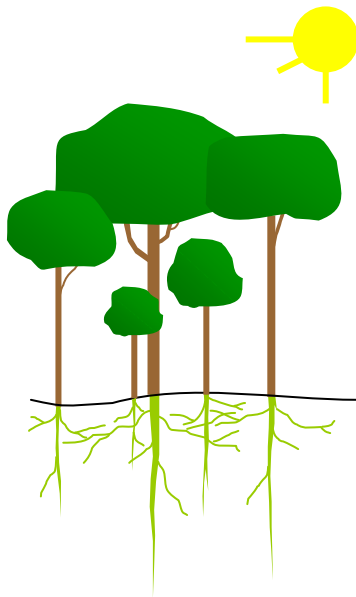

Como representar estes processos?

>> simplificação <<

# Modelagem Ambiental

## Classificação

- \* determinístico ou estocástico
- \* baseado em processos ou empírico
- \* contínuo ou discreto
- \* pontual ou distribuído
- \* estático ou dinâmico

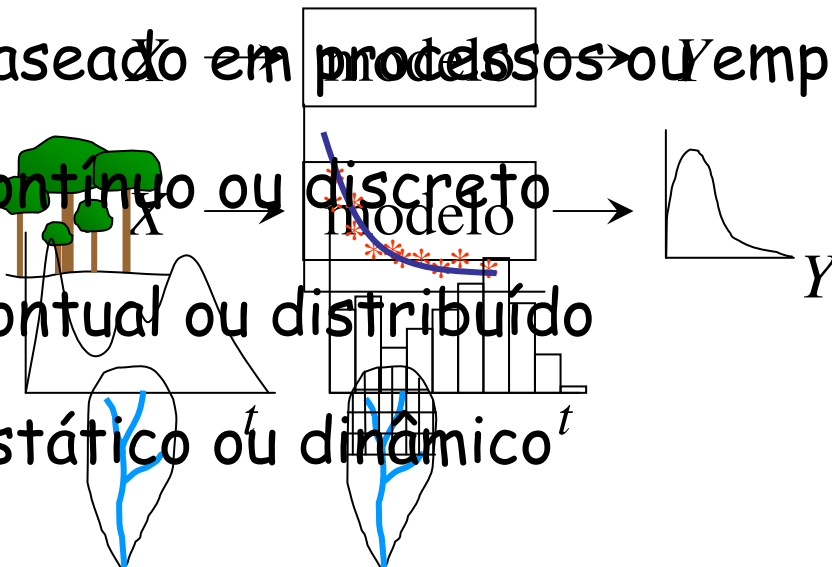

# Ciclo Hidrológico

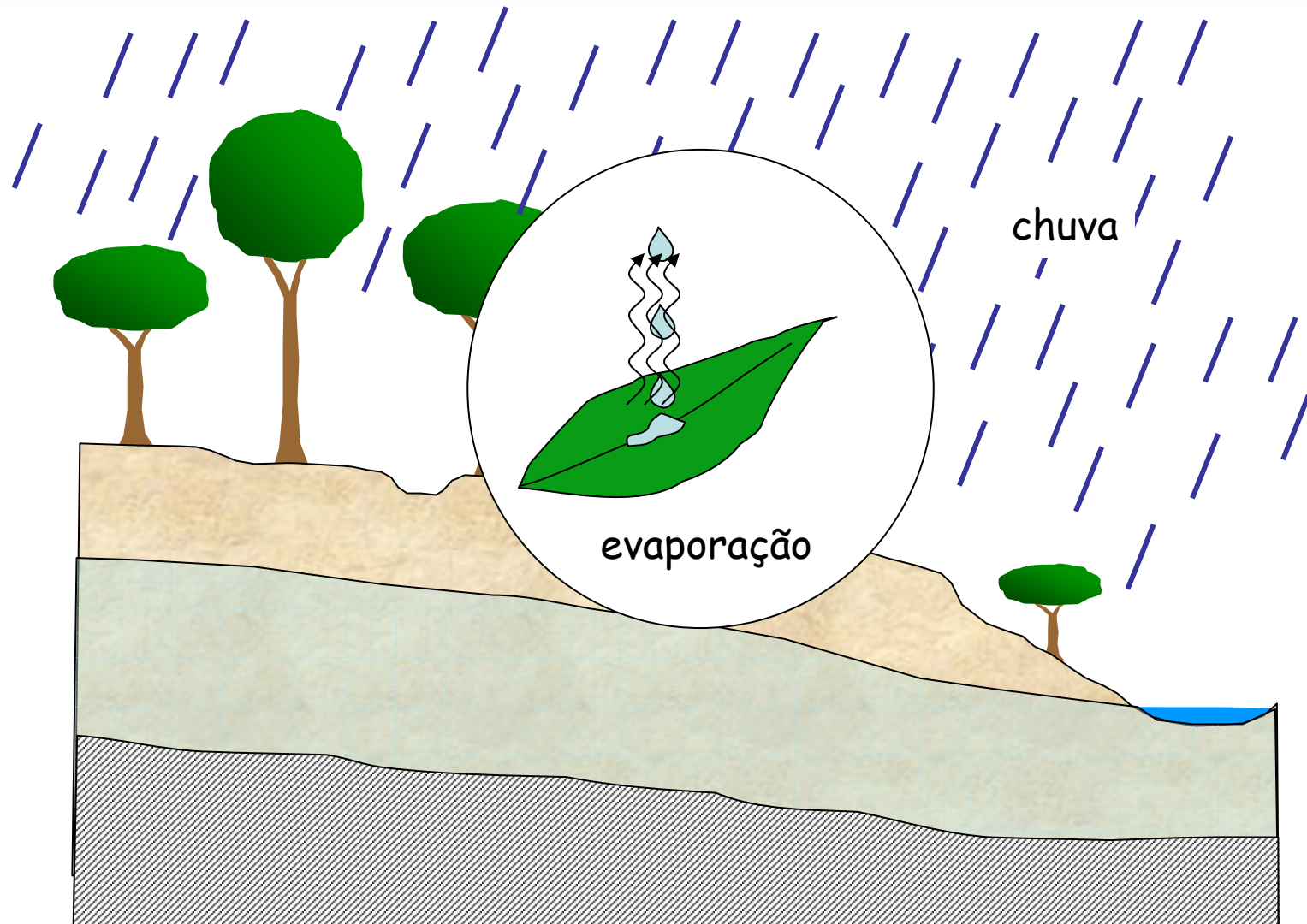



# Ciclo Hidrológico

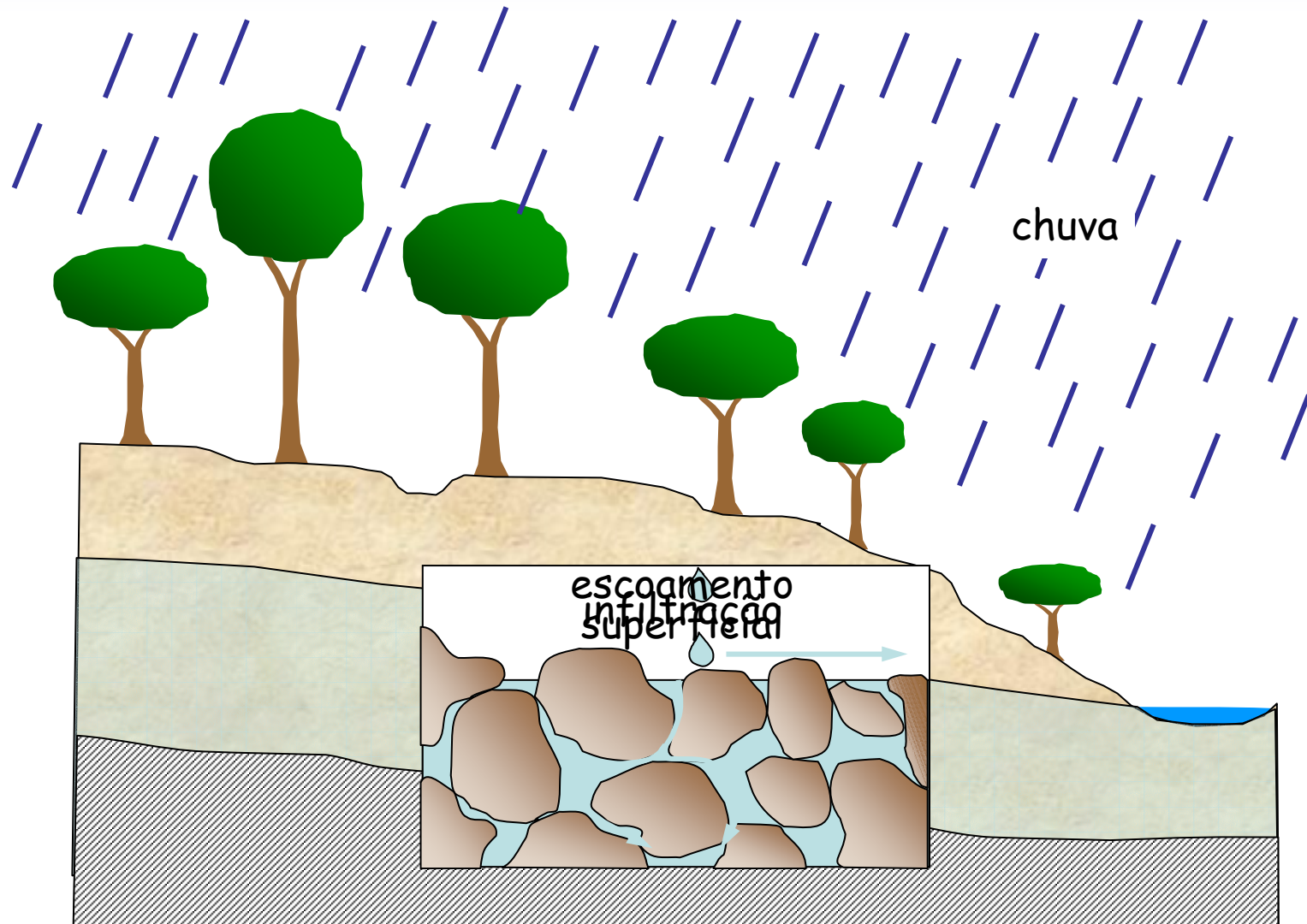

# Ciclo Hidrológico

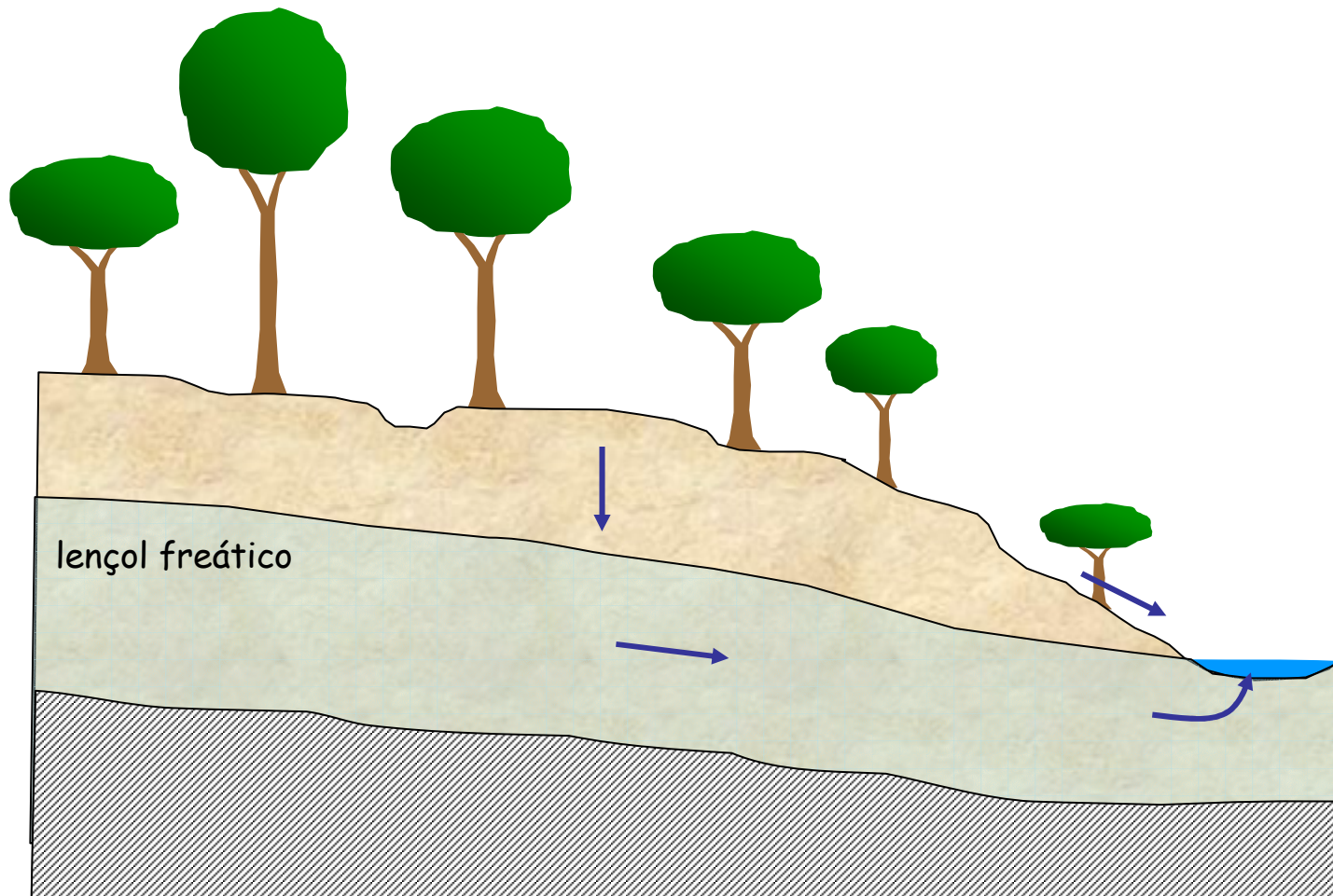

# Ciclo Hidrológico

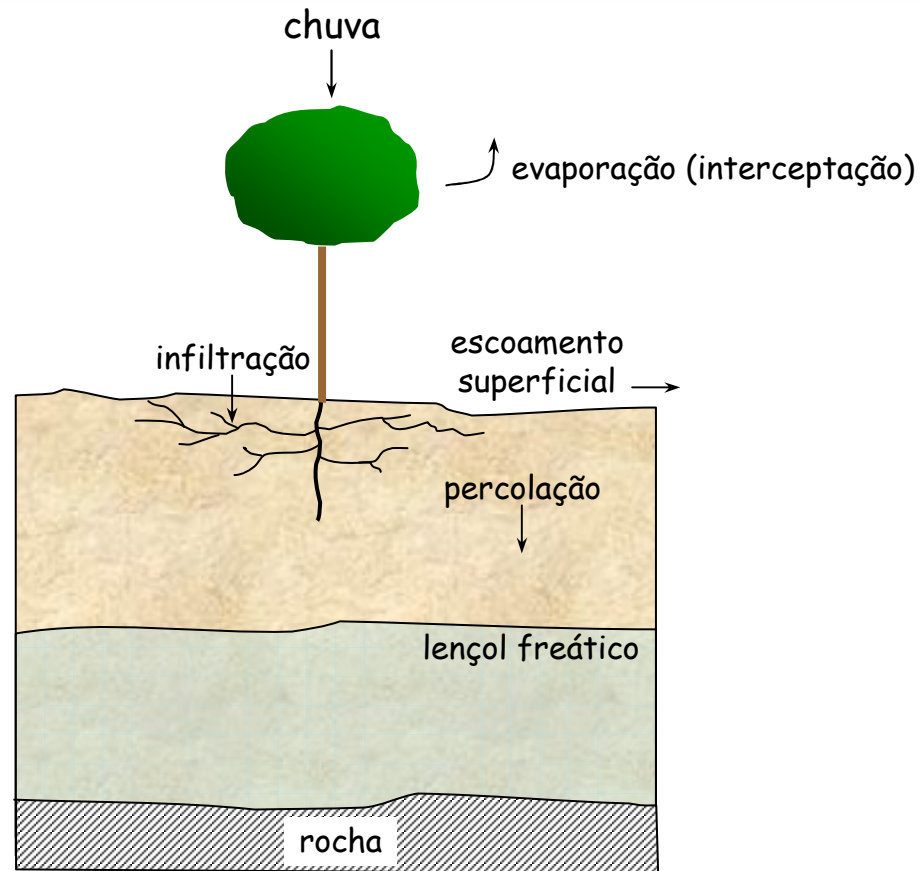

# Ciclo Hidrológico

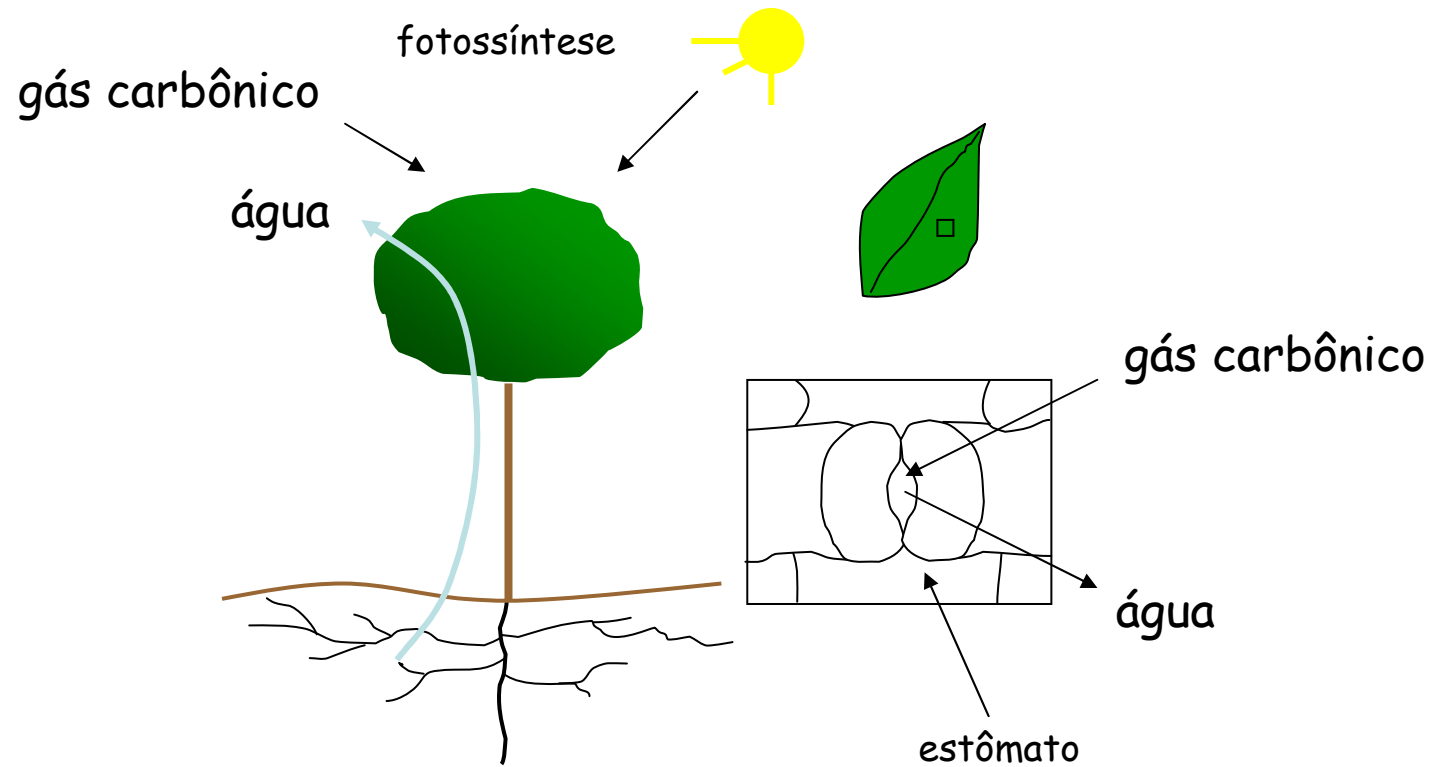

# Ciclo Hidrológico

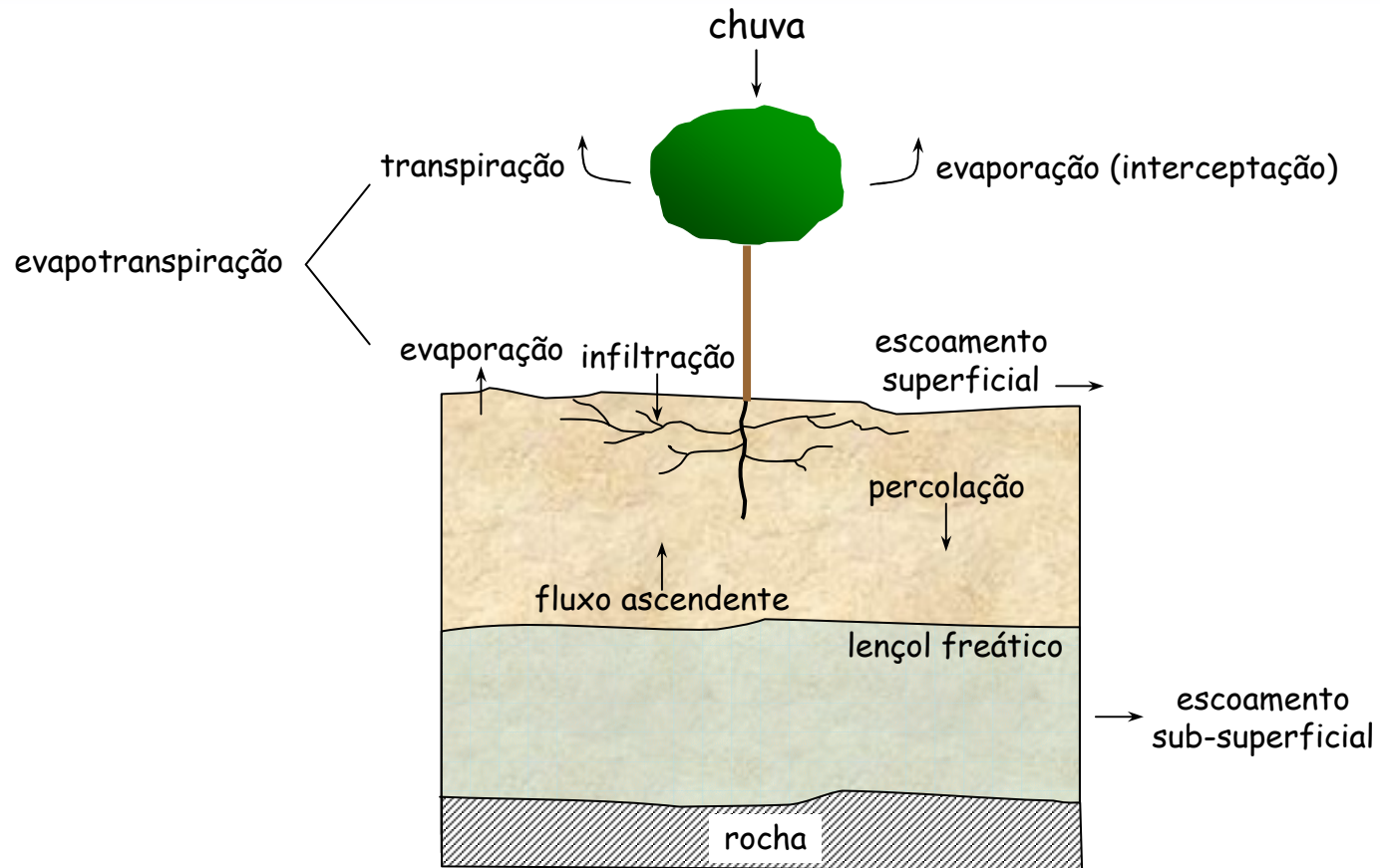

# Modelo Hidrológico

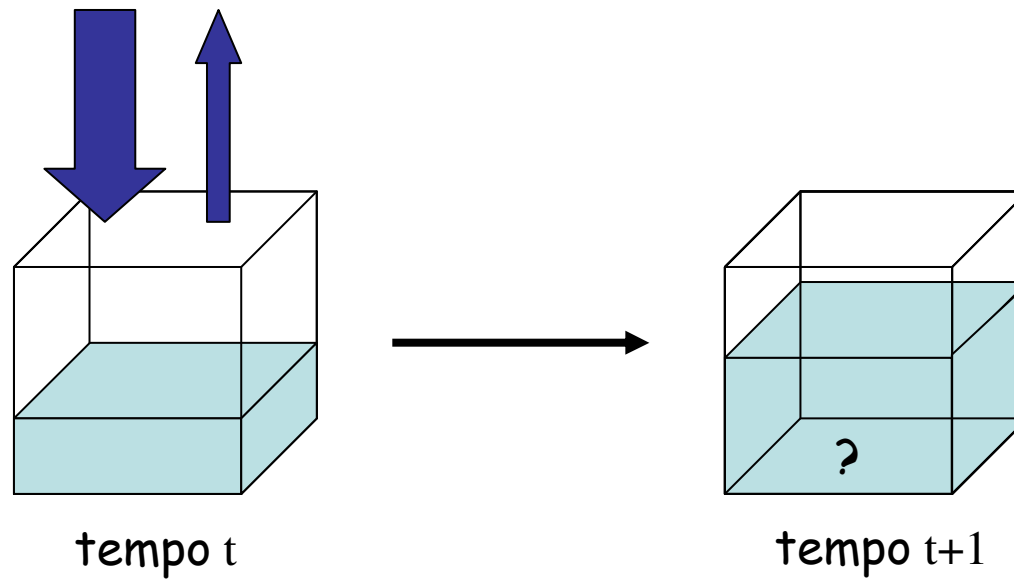

$$V_{t+1} = V_t + E_t - S_t$$

# Modelo Hidrológico

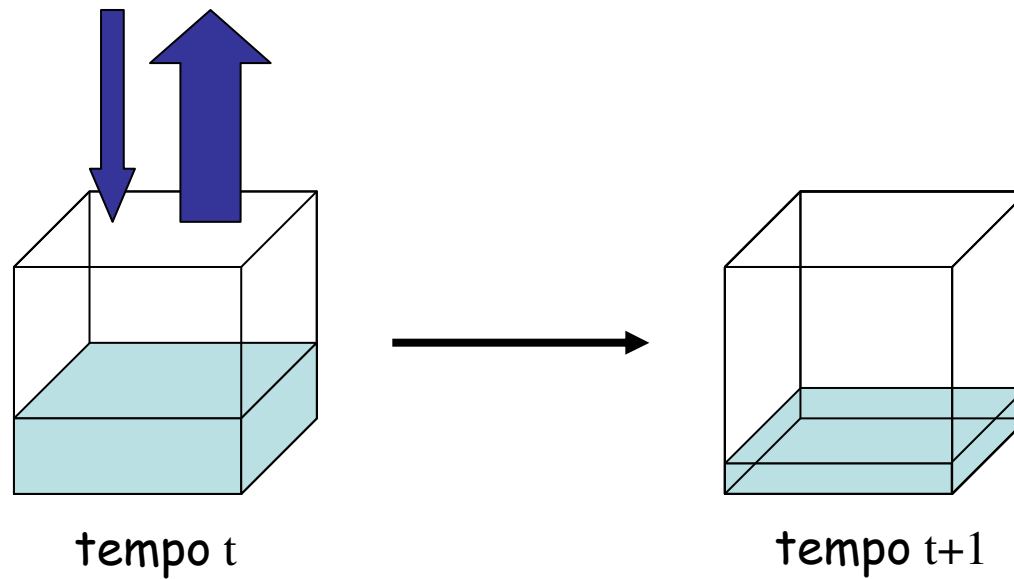

$$V_{t+1} = V_t + E_t - S_t$$

# Modelo Hidrológico Distribuído

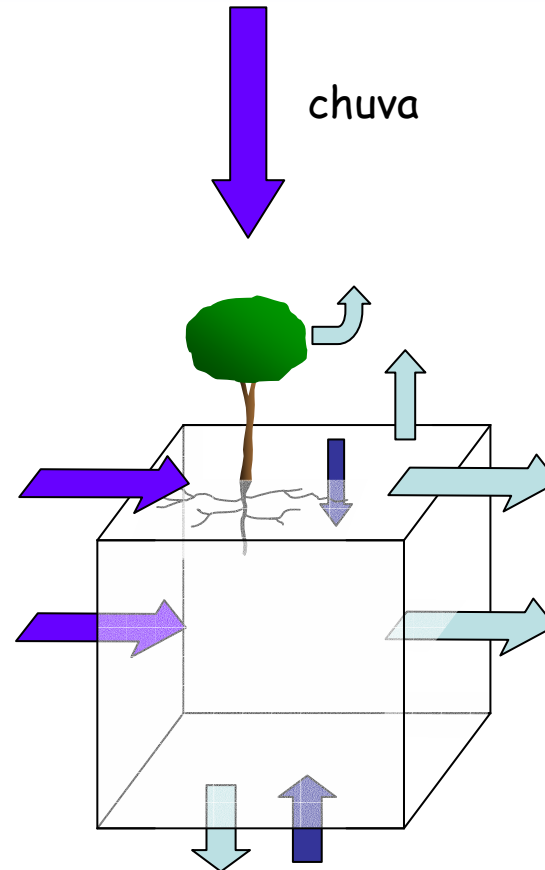
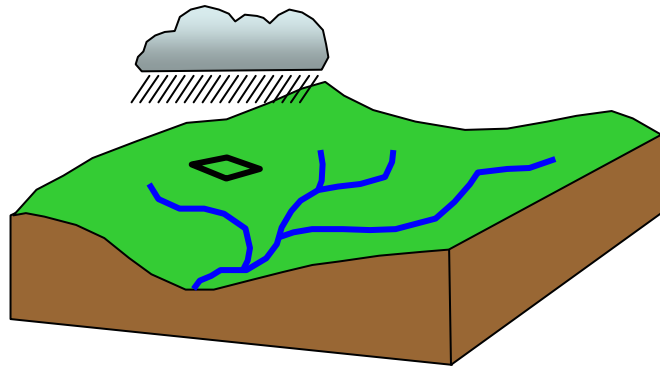

quanto?  
para onde?  
em quanto tempo?



# Bacia Hidrográfica

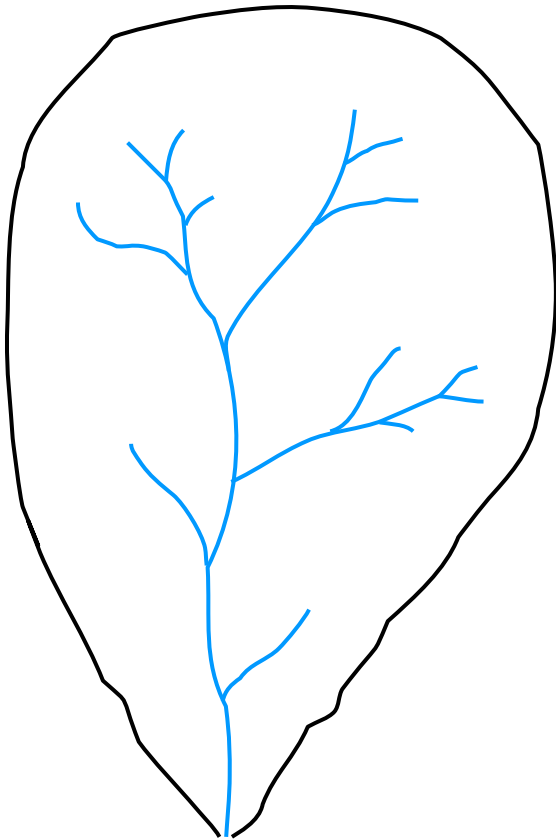

- \* unidade hidrológica
- \* delimitada pelos divisores de água
- \* supõe-se um único ponto de saída

(divisores de água  
superficial = subsuperficial)

*mas como estudar os processos hidrológicos  
dentro de uma bacia?*

**Discretização Espacial**

# Discretização em Sub-bacias

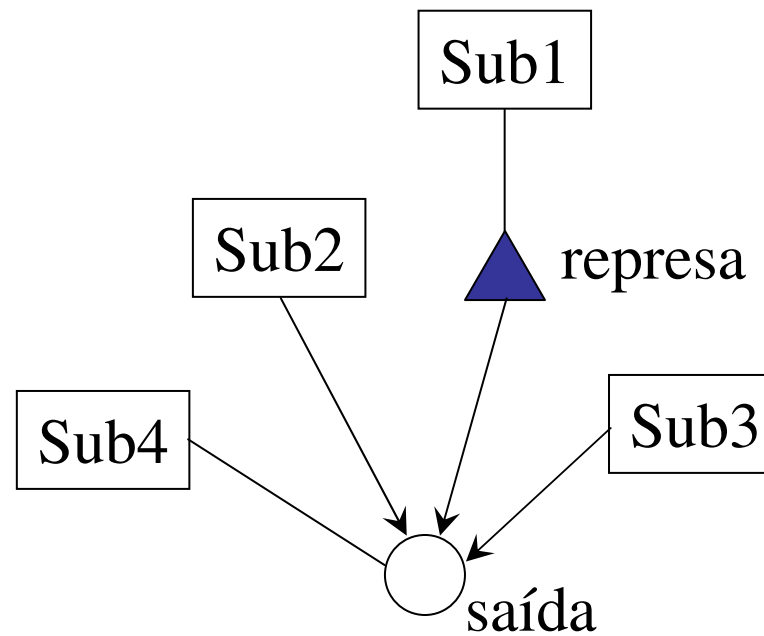
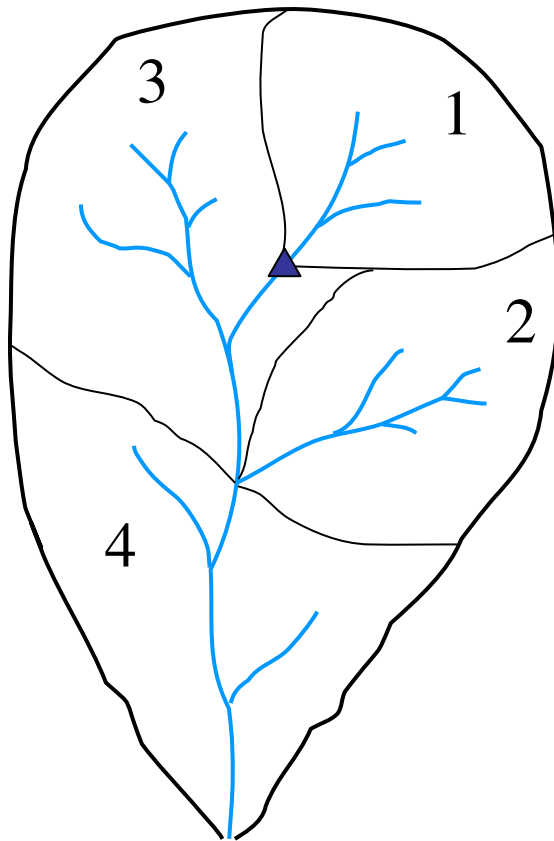

# Discretização em Grade Regular

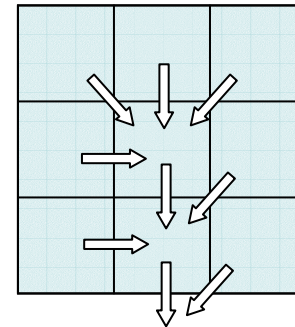
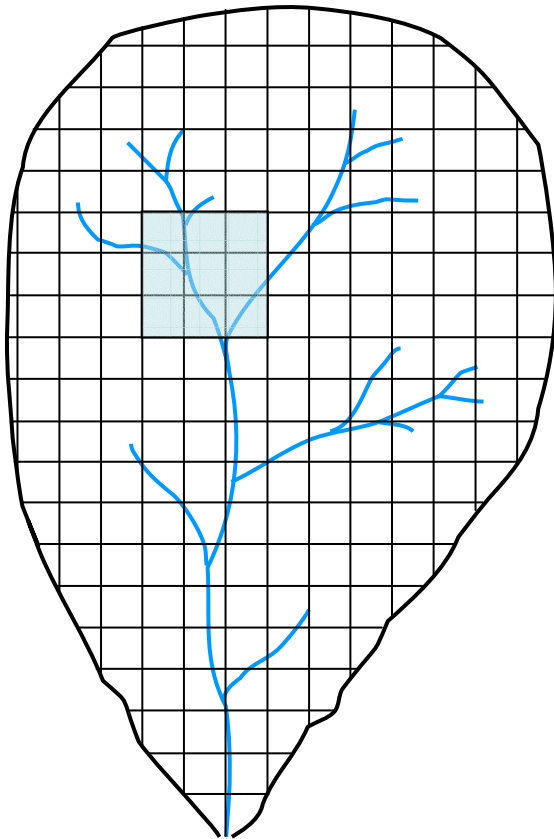

- ✓ fácil representação e manipulação
- ✓ topologia implícita
- ✓ correspondência com dados matriciais

# Dinâmica de Água no Solo

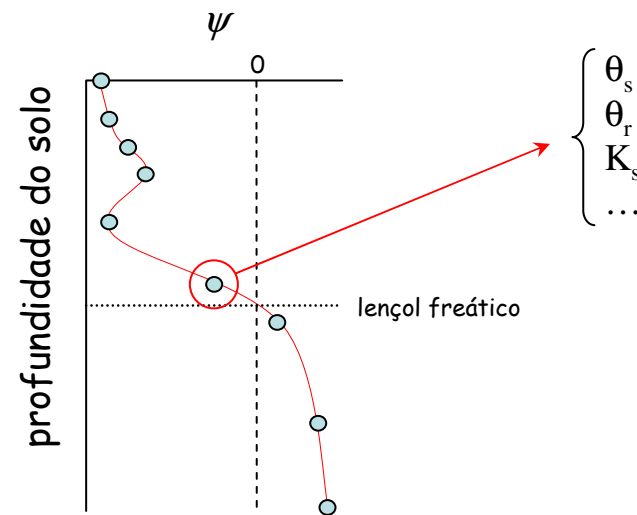
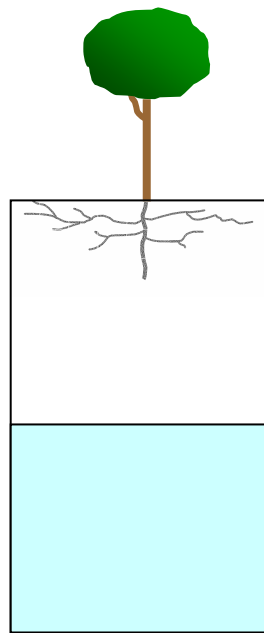

# Dinâmica de Água no Solo

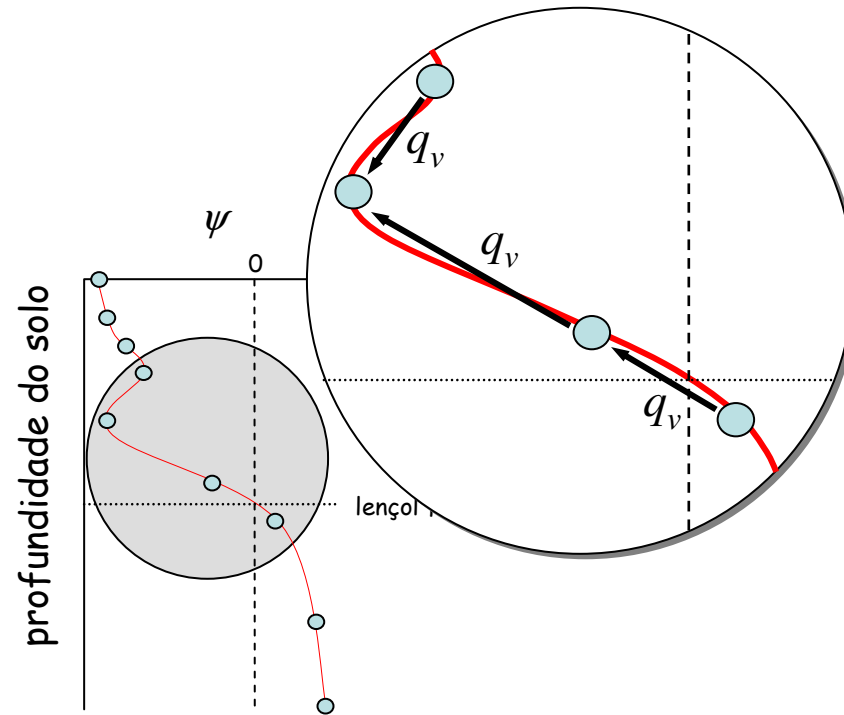
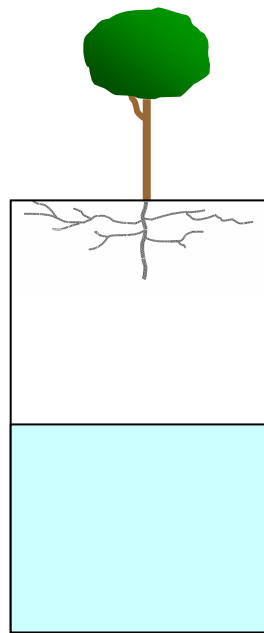

# Dinâmica de Água no Solo

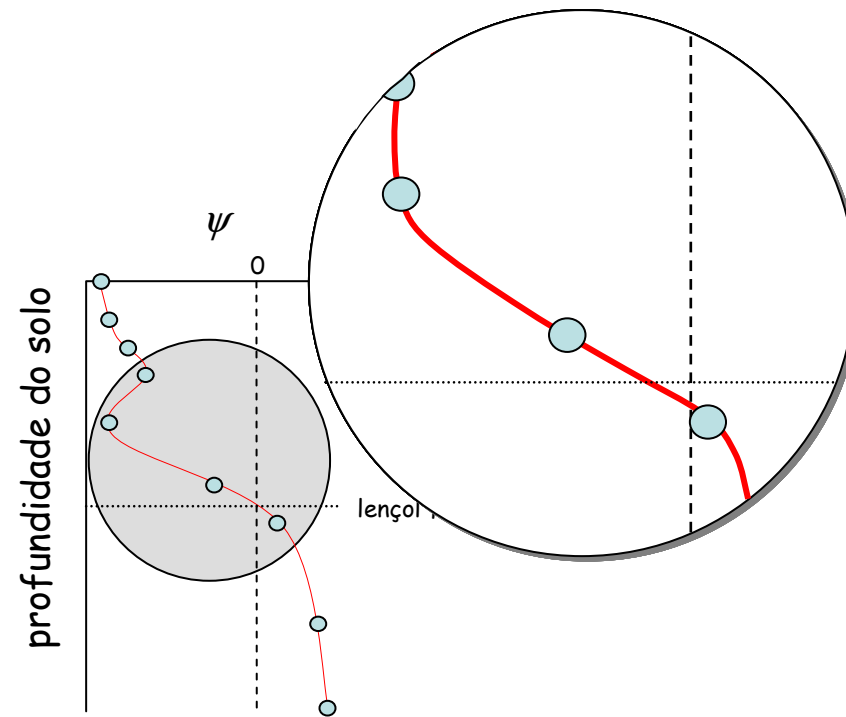
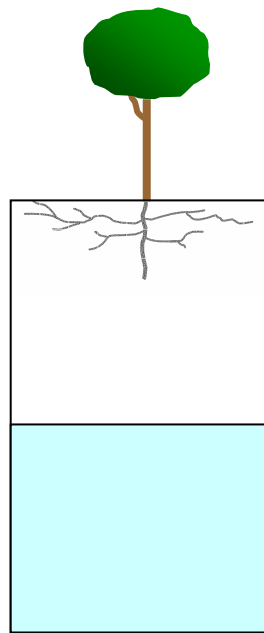

# Discretização em Grade Regular

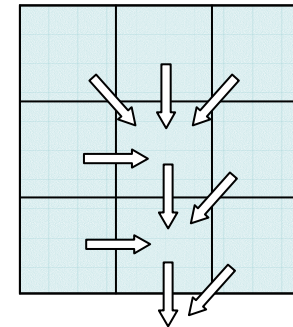
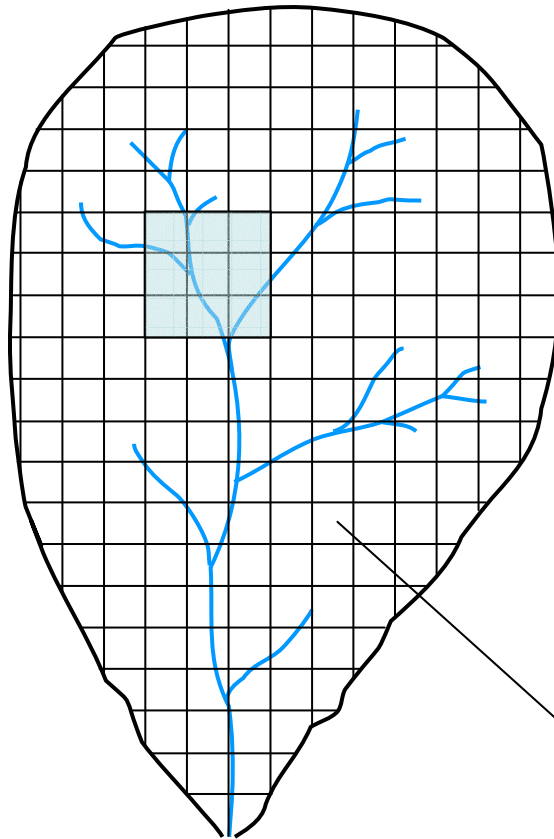

- ✓ fácil representação e manipulação
- ✓ topologia implícita
- ✓ correspondência com dados matriciais

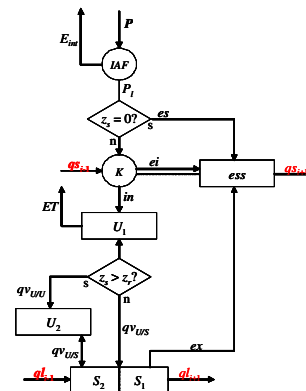
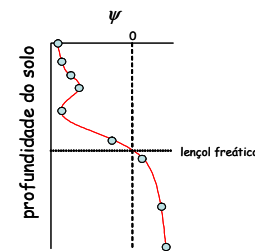

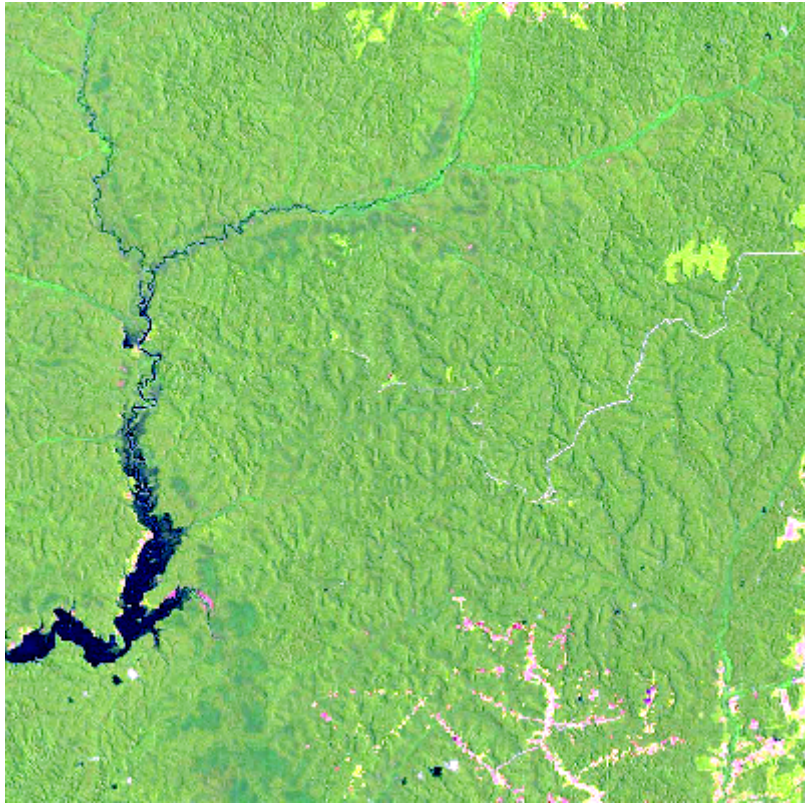

TM 543 / 2001

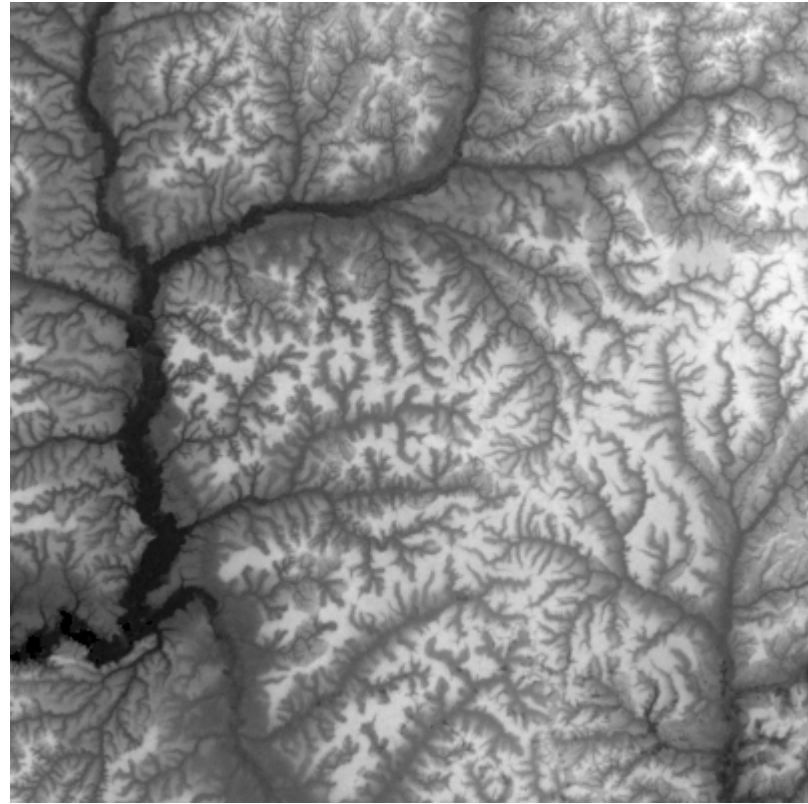

SRTM



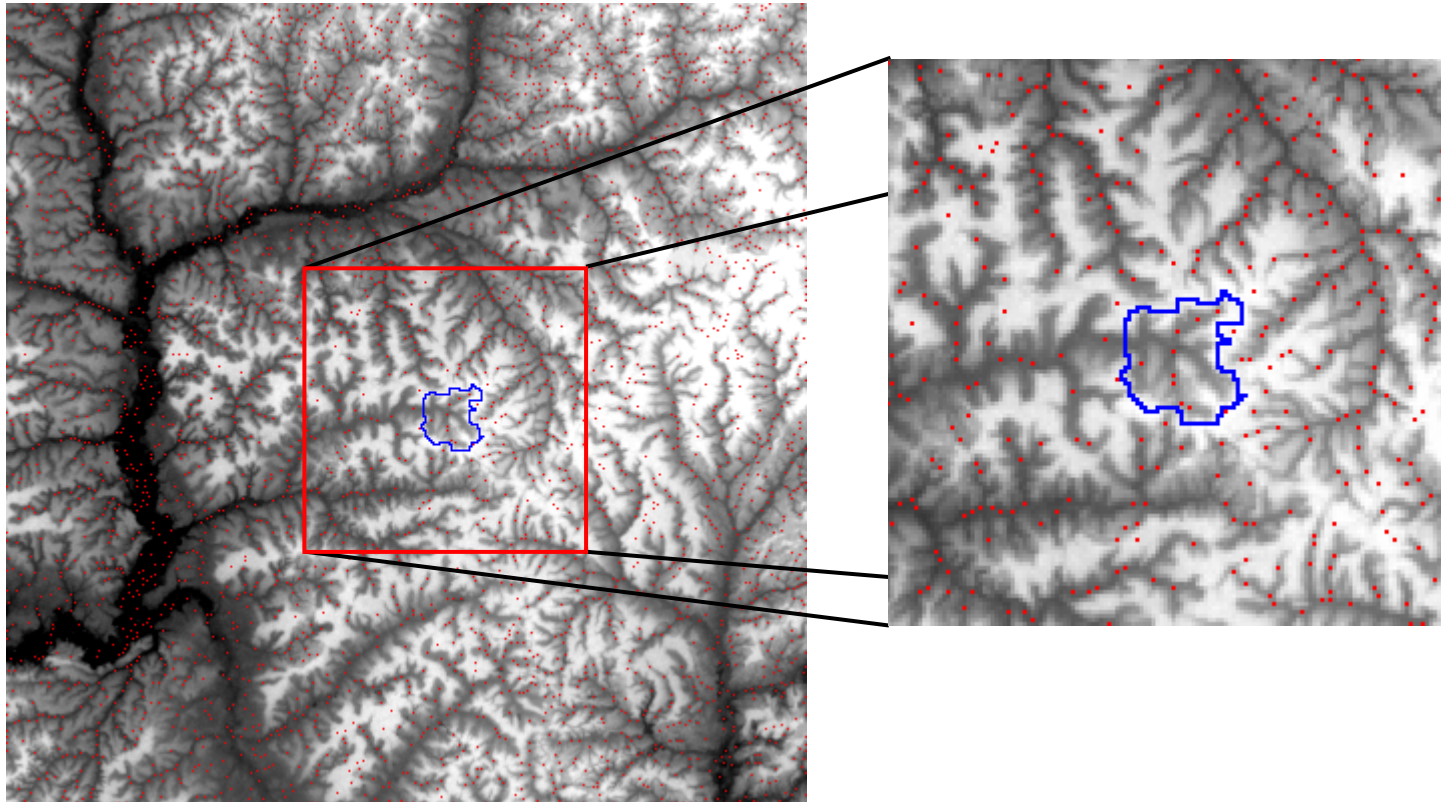

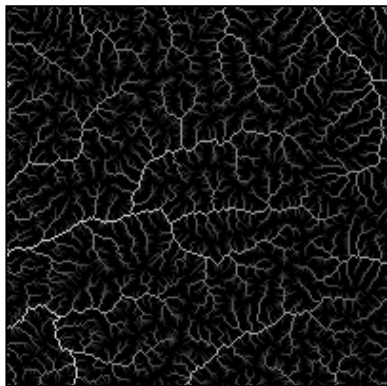

área de contribuição

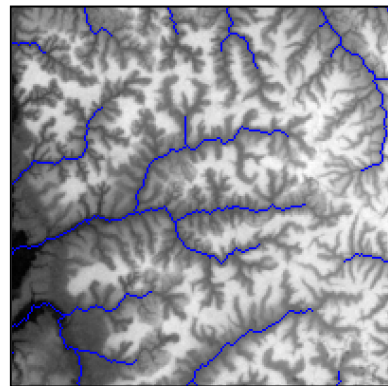

limiar = 500

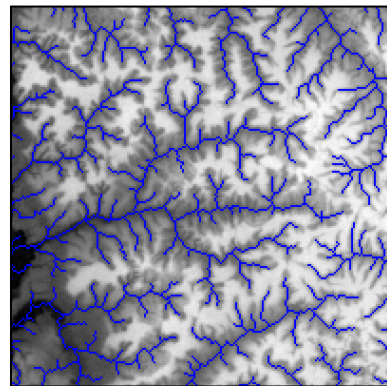

limiar = 50

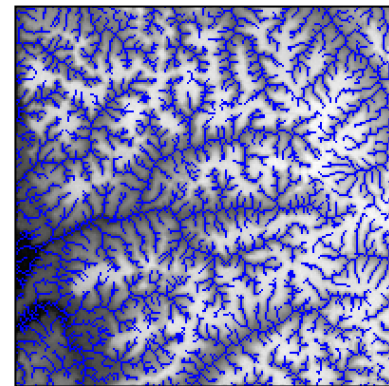

limiar = 5

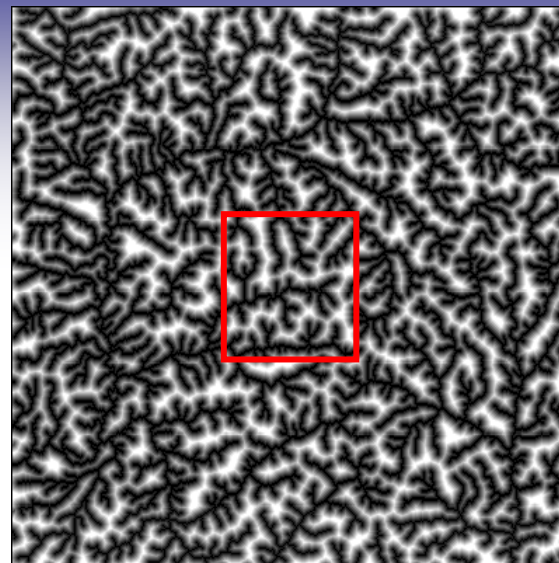
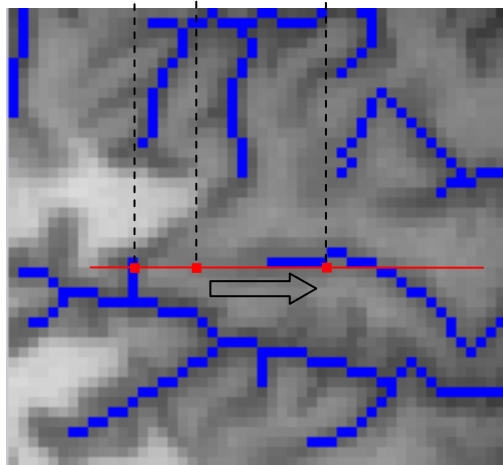
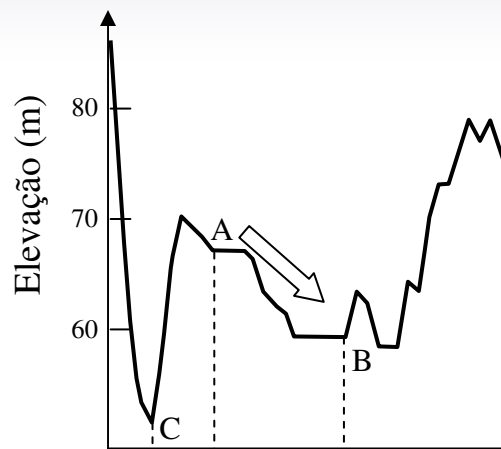

Dist. Euclidiana

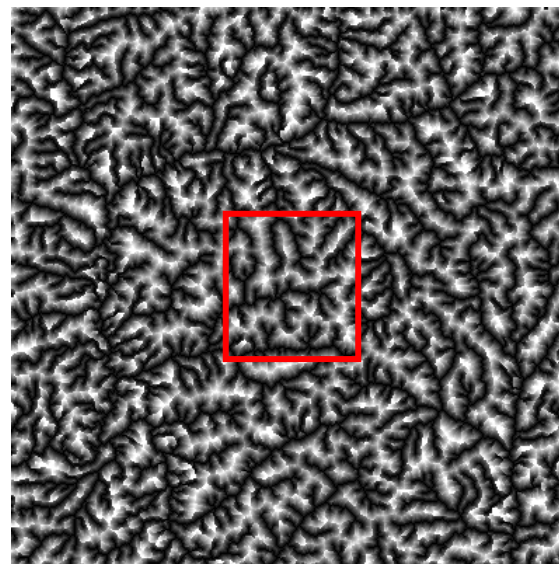
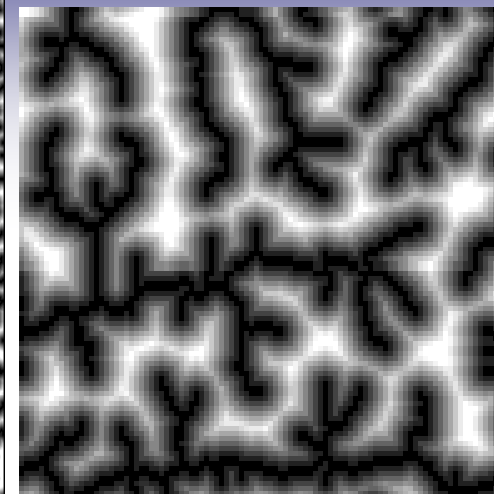

Dist. a Drenagem mais próxima

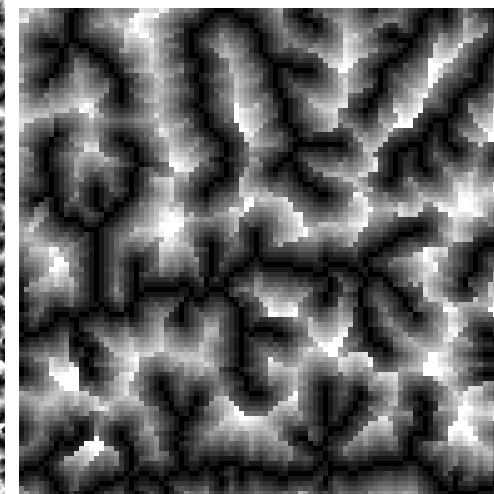

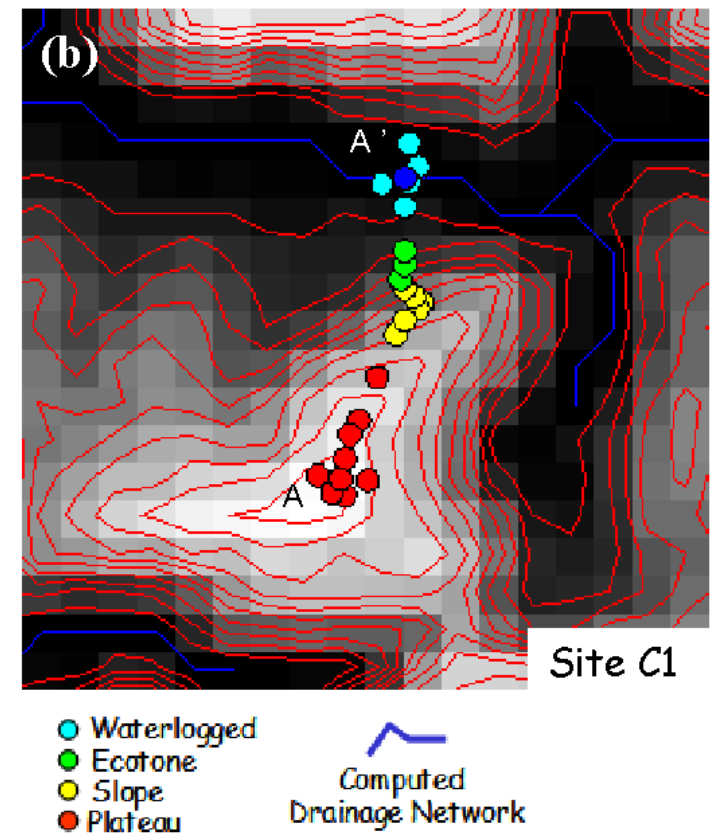
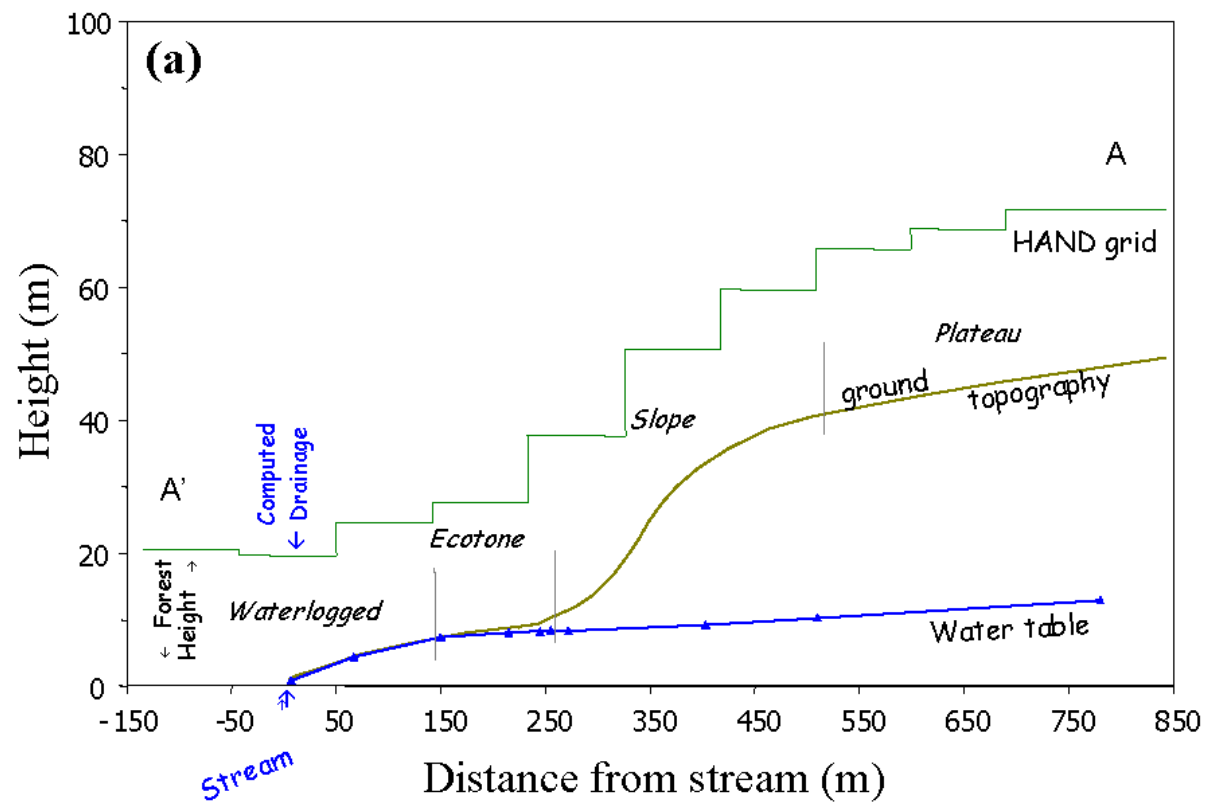

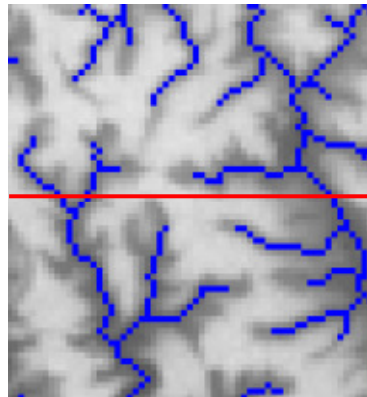
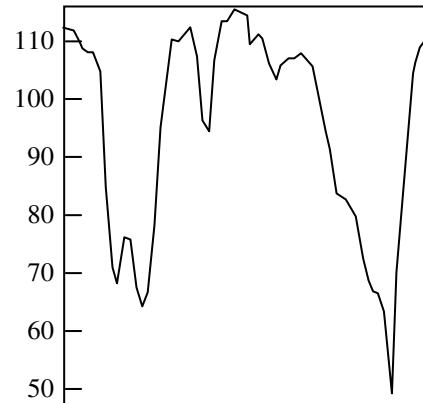

DEM

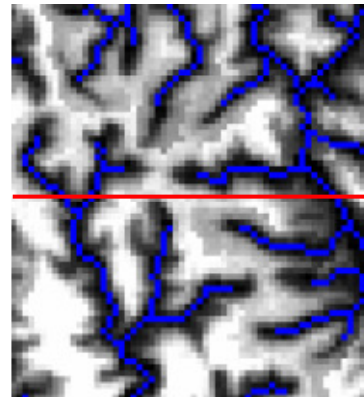
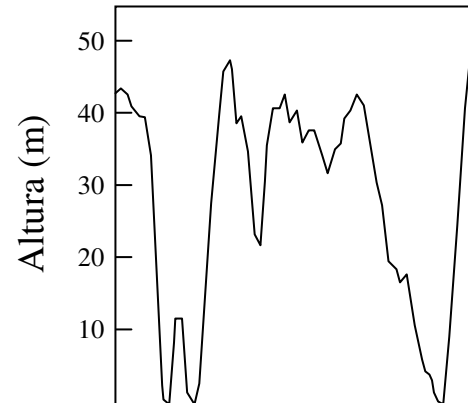

HAND

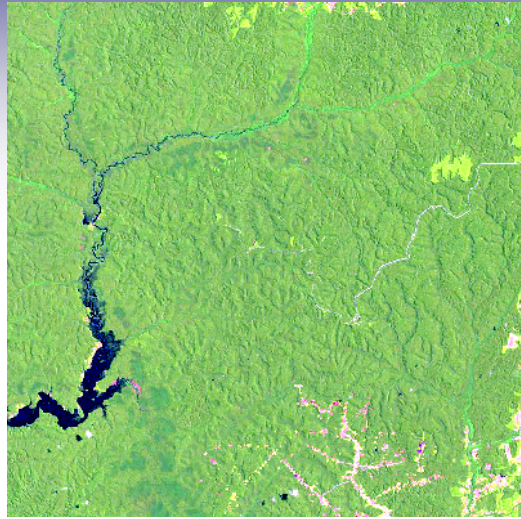

TM

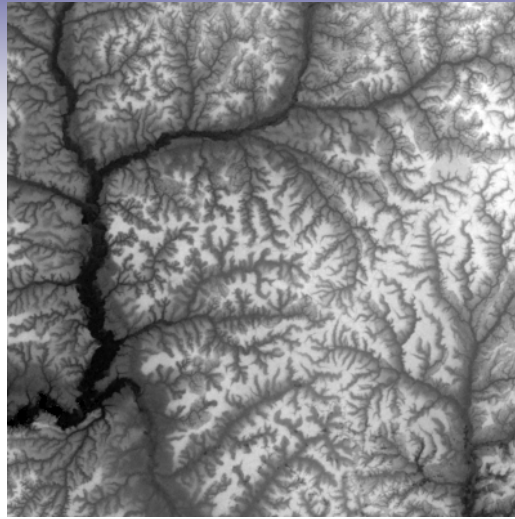

SRTM

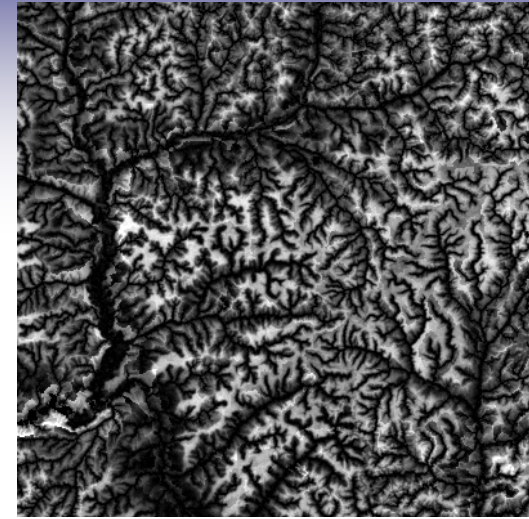

HAND

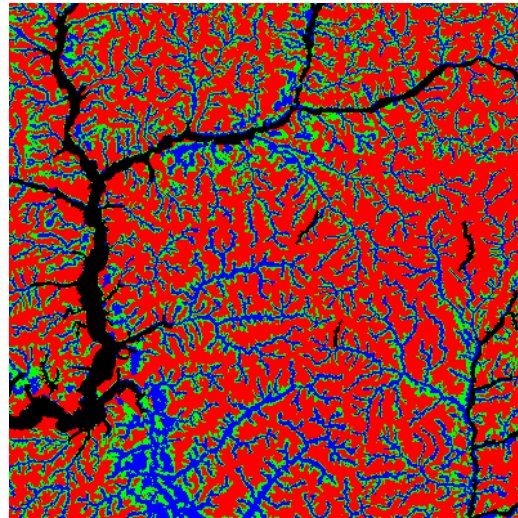
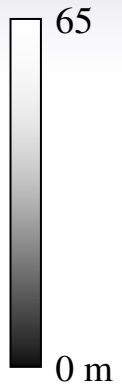

HAND 3 classes

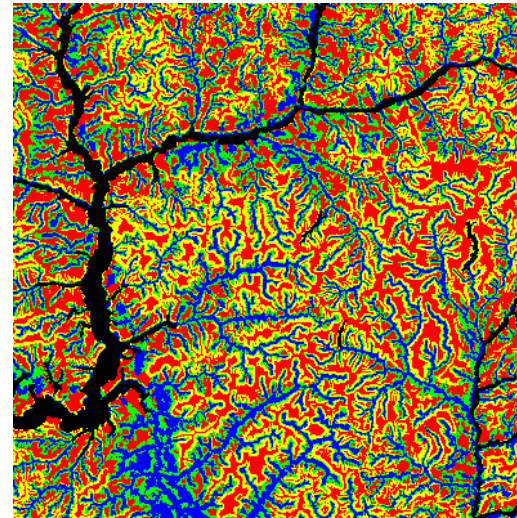

HAND 4 classes  
(+ declividade)

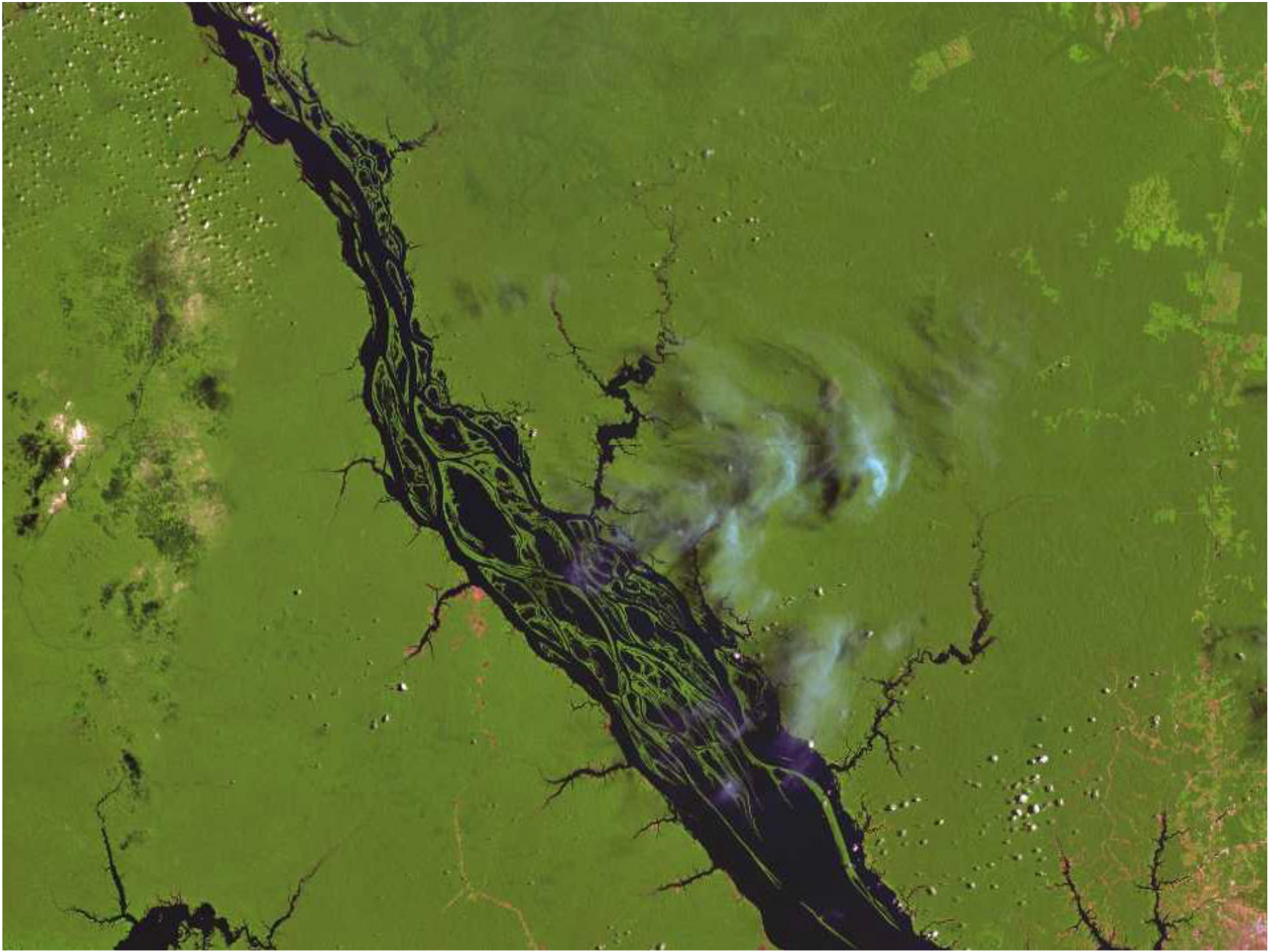

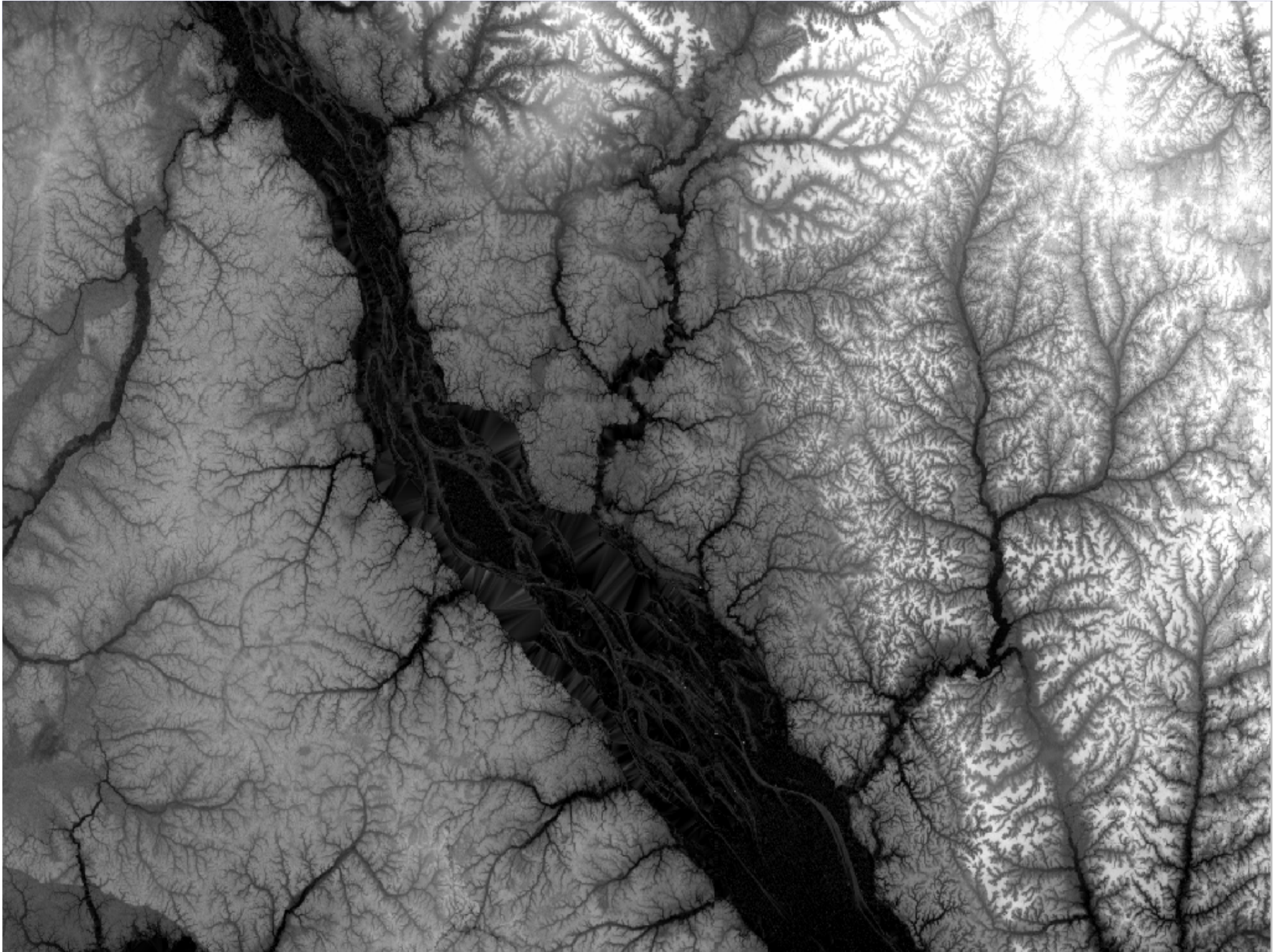



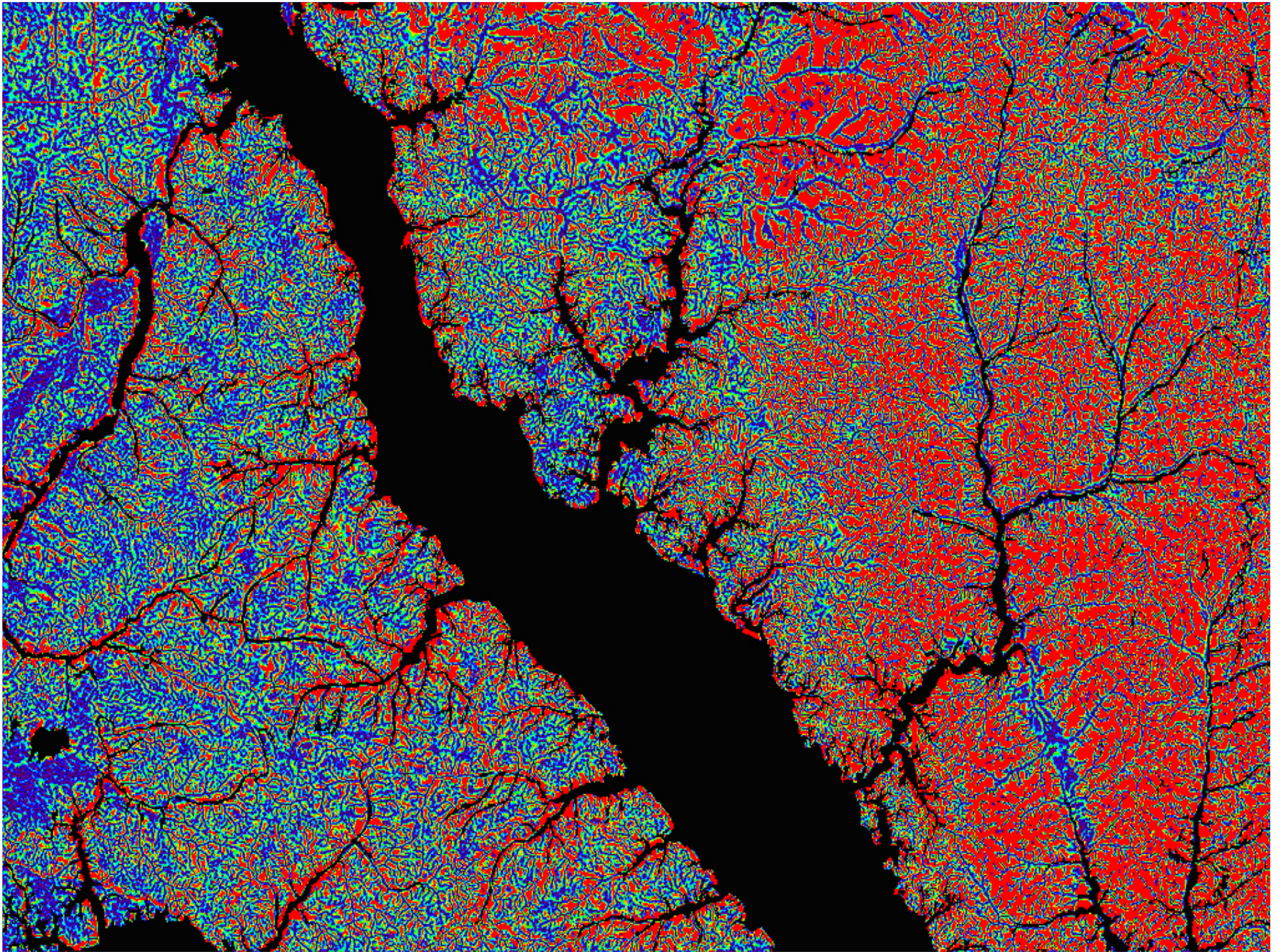

## SRTM x Desmatamento

